

Decorlux CERAMICS

戴思瓷磚

产品图册
CATALOGUE

DIRECTORY 目录

FASHION TERRAZZO 时尚水磨石系列 05~22

OUTDOOR LANDSCAPE 景观砖系列 23~34

MORDEN GLAZED PORCELAIN
现代仿古砖系列 35~40

Size / Thickness

产品规格：300X600mm、600X600mm、600X900mm、600X1200mm

厚度：

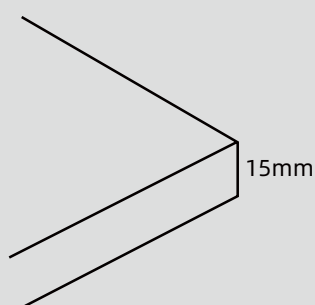

厚度 Thickness:15mm

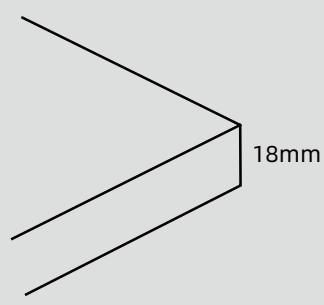

厚度 Thickness:18mm

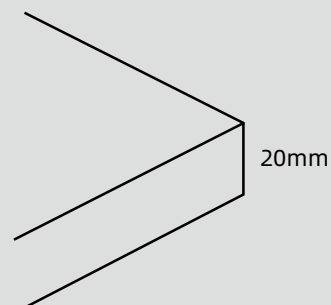

厚度 Thickness:20mm



TRA ARTE E MODA
IMAGINE

FASHION TERRAZZO TILE

时尚水磨石

时尚水磨石系列 Fashion Terrazzo

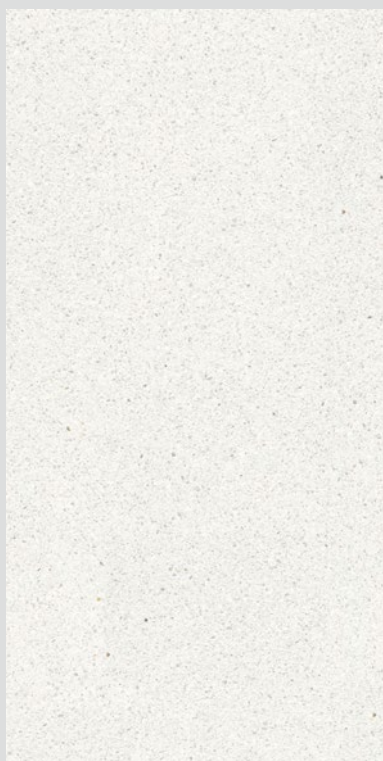

FCT612101L



FCT612109L



FCT612102L

产品属性 Attribute

规格 Size

形状 Shape

坯体 Body

600X1200mm



白坯
White Body

表面 Surface

精雕 + 细干粒 + 蜡抛

Carving Glaze + Granular + Lappato

FASHION TERRAZZO TILE

时尚水磨石

柏悦水磨石系列 Park Hyatt Terrazzo



FPT612121L



FPT612122L



FPT612123L

产品属性 Attribute

规格 Size 形状 Shape 坯体 Body

600X1200mm



斑点坯
Full Body

表面 Surface

哑面 + 精雕
Matt+ Carving Glaze

FASHION TERRAZZO TILE

时尚水磨石

时尚水磨石系列 Fashion Terrazzo

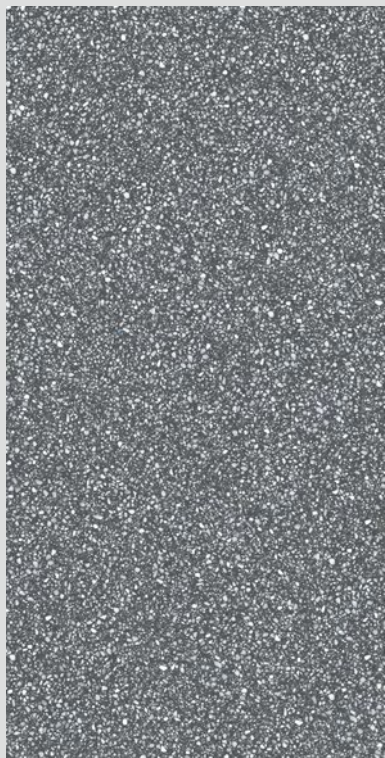

FCT612106L

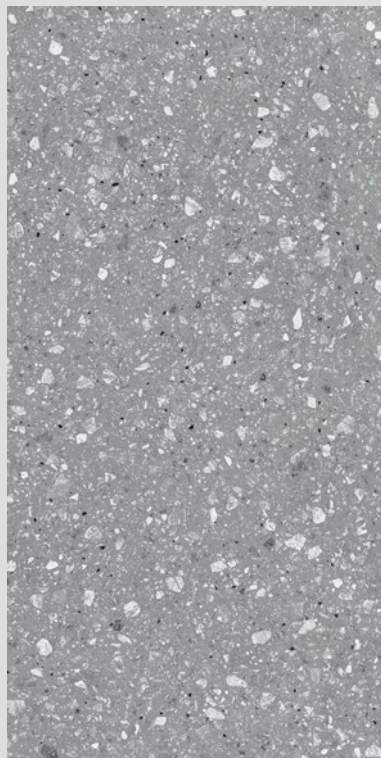

FCT612107L



FCT612108L

产品属性 Attribute

规格 Size 形状 Shape 坯体 Body

600X1200mm



白坯
White Body

表面 Surface

精雕 + 细干粒 + 蜡抛
Carving Glaze + Granular + Lappato

FASHION TERRAZZO TILE

时尚水磨石

时尚水磨石系列 Fashion Terrazzo



FMT201S



FMT202S



FCT101S



FCT102S



FCT106S

产品属性 Attribute

规格 Size

形状 Shape

坯体 Body

600X600mm



白坯
White Body

表面 Surface

精雕 + 细干粒 + 蜡抛

Carving Glaze + Granular + Lappato

FASHION TERRAZZO TILE

时尚水磨石

时尚水磨石系列 Fashion Terrazzo

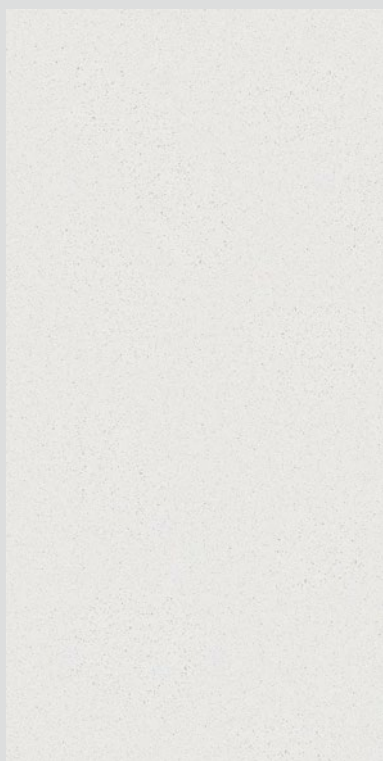

FMT612201L



FMT612202L



FMT612203L

产品属性 Attribute

规格 Size 形状 Shape 坯体 Body

600X1200mm



白坯
White Body

表面 Surface

精雕 + 细干粒 + 蜡抛
Carving Glaze + Granular + Lappato

FASHION TERRAZZO TILE

时尚水磨石

时尚水磨石系列 Fashion Terrazzo



FCT612103L(定制)

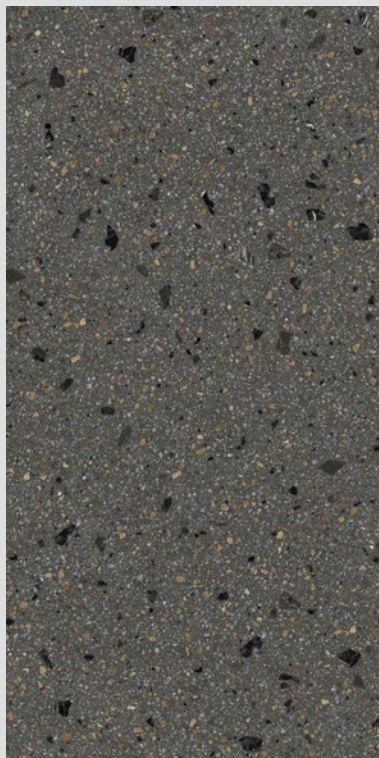

FCT612105L(定制)

产品属性 Attribute

规格 Size	形状 Shape	坯体 Body
---------	----------	---------

600X1200mm



白坯
White Body

表面 Surface

精雕 + 细干粒 + 蜡抛
Carving Glaze + Granular + Lappato

FASHION TERRAZZO TILE

时尚水磨石

彩色水磨石系列 Colorful Terrazzo



FCT601S



FCT608S



FCT609S

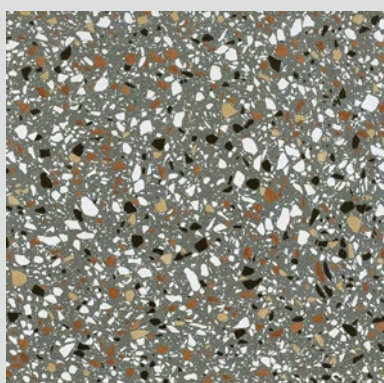

FCT611S

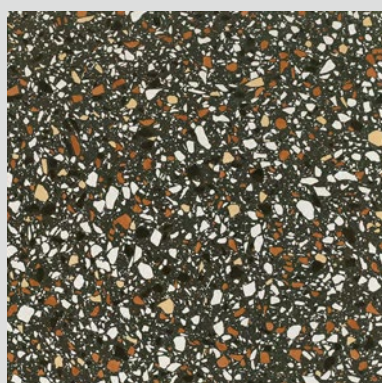

FCT612S

产品属性 Attribute

规格 Size

形状 Shape

坯体 Body

600X600mm



普坯
Normal Body

表面 Surface

精雕 + 半抛

Carving Glaze + Lappato

FASHION TERRAZZO TILE

时尚水磨石

彩色水磨石系列 Colorful Terrazzo



FCT612601L



FCT612608L

产品属性 Attribute

规格 Size

形状 Shape

坯体 Body

600X1200mm



白坯
White Body

表面 Surface

精雕 + 半抛

Carving Glaze + Lappato

FASHION TERRAZZO TILE

时尚水磨石

托斯卡纳水磨石系列 Tuscany Terrazzo



FCT612301

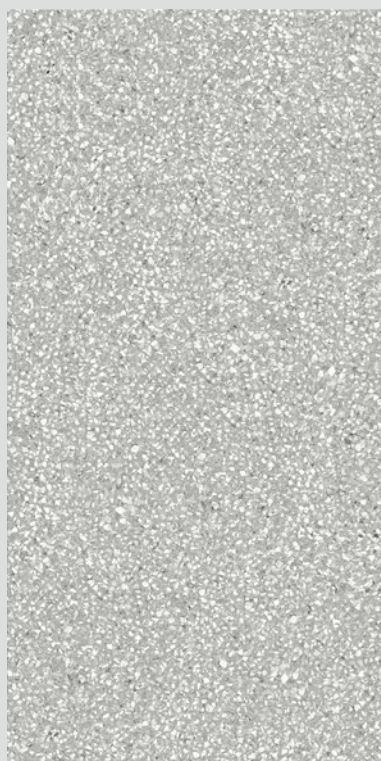

FCT612302

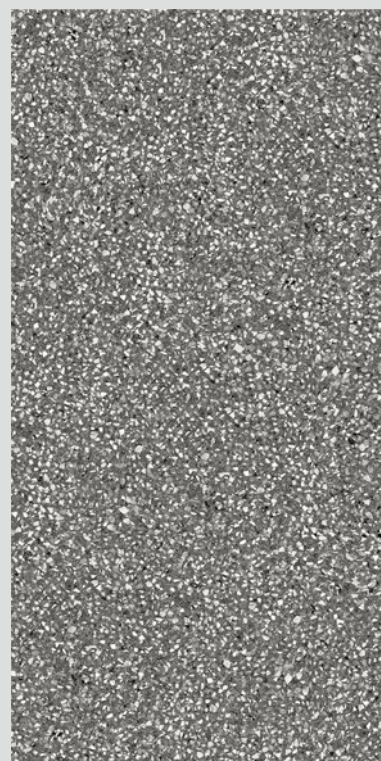

FCT612303

产品属性 Attribute

规格 Size 形状 Shape 坯体 Body

600X1200mm



斑点坯
Full Body

表面 Surface

哑面 + 精雕
Matt+ Carving Glaze



FASHION TERRAZZO TILE

时尚水磨石

博洛那水磨石系列 Bologna Terrazzo



BLA01M (哑面)
BLA01SP (半抛)
BLA01R (干粒防滑面)

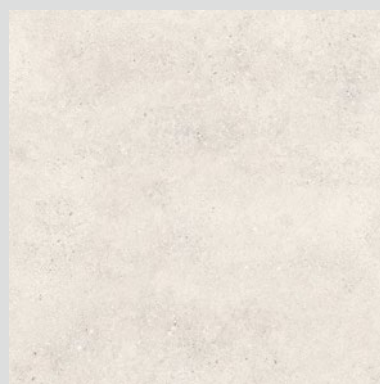

BLA02M (哑面)
BLA02SP (半抛)
BLA02R (干粒防滑面)



BLA03M (哑面)
BLA03SP (半抛)
BLA03R (干粒防滑面)



BLA04M (哑面)
BLA04SP (半抛)
BLA04R (干粒防滑面)

产品属性 Attribute

规格 Size	形状 Shape	坯体 Body
---------	----------	---------

600X600mm



斑点坯
Full Body

表面 Surface

哑面 / 半抛 / 干粒防滑面
Matt/Lappatto/Anti-slip R11

FASHION TERRAZZO TILE

时尚水磨石

博洛那水磨石系列 Bologna Terrazzo



F612BLA02M



F612BLA03M

产品属性 Attribute

规格 Size	形状 Shape	坯体 Body
---------	----------	---------

600X1200mm



斑点坯
Full Body

表面 Surface

哑面
Matt

FASHION TERRAZZO TILE

时尚水磨石

摩迪纳水磨石系列 Morden Terrazzo



F66MTA03M (哑面)
F66MTA03SP (半抛) (定制)



F66MTA04M (哑面)
F66MTA04SP (半抛) (定制)



F66MTA05M (哑面)
F66MTA05SP (半抛) (定制)

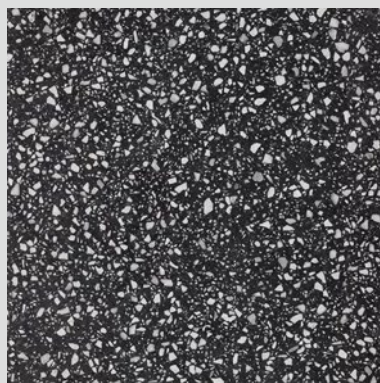

F66MTA06M (哑面)
F66MTA06SP (半抛) (定制)

产品属性 Attribute

规格 Size 形状 Shape 坯体 Body

600X600mm



斑点坯
Full Body

表面 Surface

哑面 / 半抛
Matt/Lappatto

FASHION TERRAZZO TILE

时尚水磨石

威尼斯水磨石系列 VeniceTerrazzo



F66TE01R



F66TE02R



F66TE03R

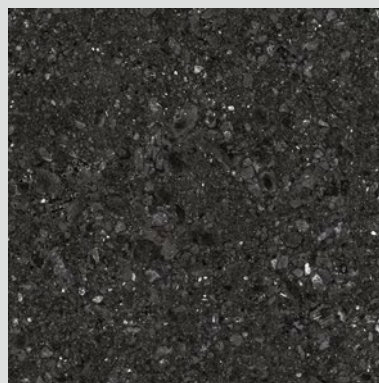

F66TE04R

产品属性 Attribute

规格 Size	形状 Shape	坯体 Body
---------	----------	---------

600X600mm



斑点坯
Full Body

表面 Surface

哑光模具面
Matt+Structrued

FASHION TERRAZZO TILE

时尚水磨石

瓦伦西亚系列 Pietra Argenta



PAT601M
(白坯 White Body)

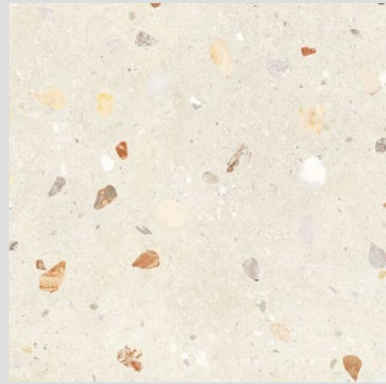

PAT602M
(白坯 White Body)



PAT603M
(灰坯 Color Body)



PAT609M
(灰坯 Color Body)

产品属性 Attribute

规格 Size

形状 Shape

坯体 Body

600X600mm



白坯 / 灰坯
White Body/Color Body

表面 Surface

哑光模具面
Matt+Structrued



FASHION TERRAZZO TILE

时尚水磨石

丽世水磨石系列 Lux Terrazzo



FPT612315M



FPT612316M



FPT612317M

产品属性 Attribute

规格 Size 形状 Shape 坯体 Body

600X1200mm



斑点坯
Full Body

表面 Surface

哑面 + 精雕
Matt+ Carving Glaze

FASHION TERRAZZO TILE

时尚水磨石

安缦水磨石系列 Aman Terrazzo



FMT612201L



PM612117M



PAM612118M

产品属性 Attribute

规格 Size 形状 Shape 坯体 Body

600X1200mm



白坯
White Body

表面 Surface

哑面 + 精雕
Matt + Carving Glaze

SIZE: 600x1200x18mm 景观厚砖

ONE STONE N FACE



Natural Wooden Stone | 木化石



WMH01



WMH02

Surface: Cranular+Lappatto 干粒 + 蜡抛 | Body: Full Body 斑点坯



SIZE: 600x1200x18mm 景观厚砖

ONE STONE N FACE



Turin Oak Art | 都灵岩画



MR60161218H



MR60261218H



MR60361218H



MR60961218H

Surface: Matt+Carving Glazed 哑面 + 精雕 | Body: Full Body 斑点坯



SIZE: 600x1200x18mm 景观厚砖

ONE STONE IN FACE

N

Basalt Sandtone | 玄武岩



DN0761218H



DN0861218H



DN0961218H

Surface: Matt 仿古面 | Body: FullBody 斑点坯

Windham Grey | 温德姆灰

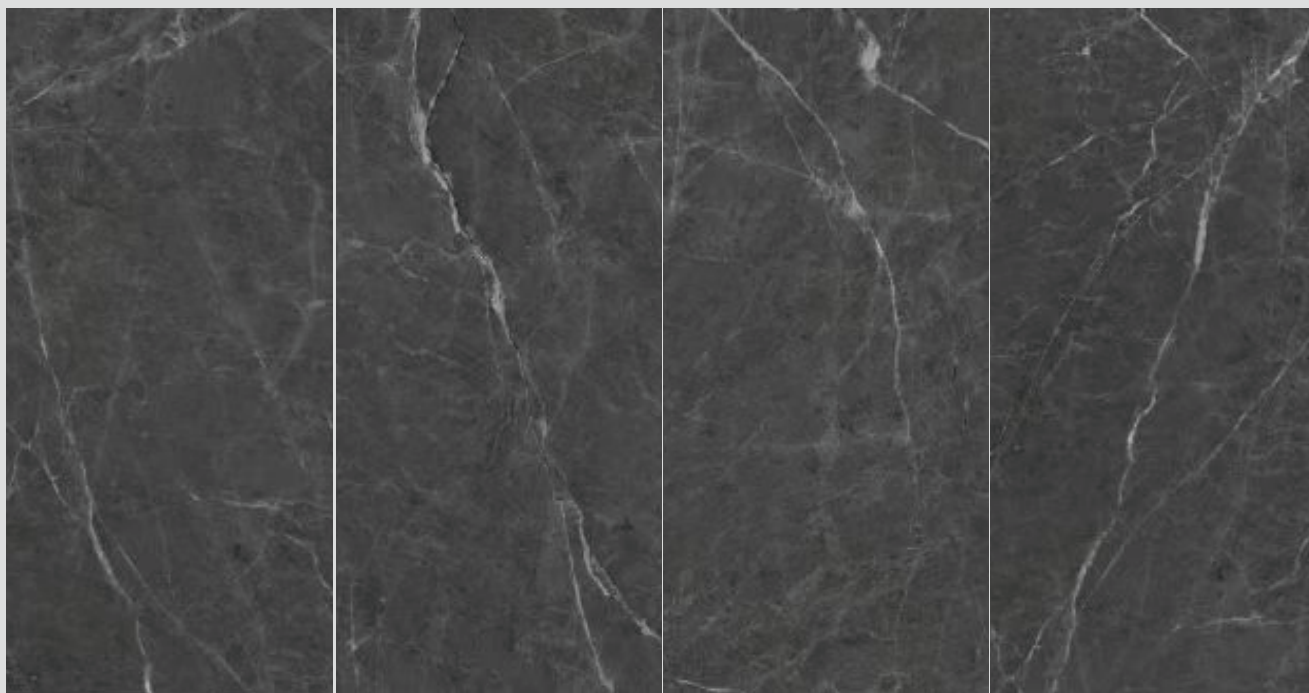

M05961218H

Surface: Matt 仿古面 | Body: FullBody 斑点坯

SIZE: 600x1200x18mm 景观厚砖

ONE STONE N FACE

N

Aquilaria Beige Stone | 沉香米黄

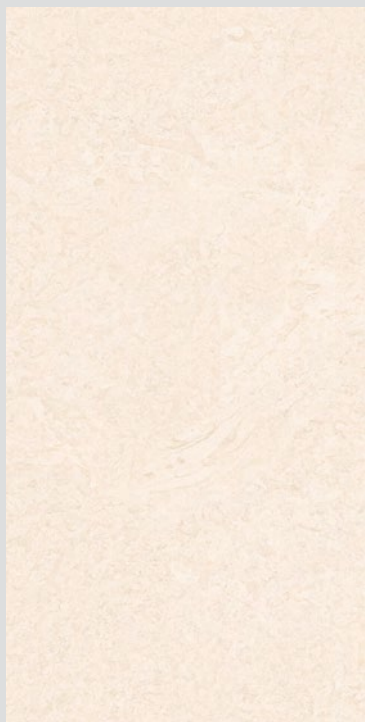

M00161218H

Surface: Matt 仿古面 / Full Polished Glazed 全抛釉
Body: FullBody 斑点坯

Portugal Beige | 葡萄牙米白



M01261218H

Carrara | 爵士白

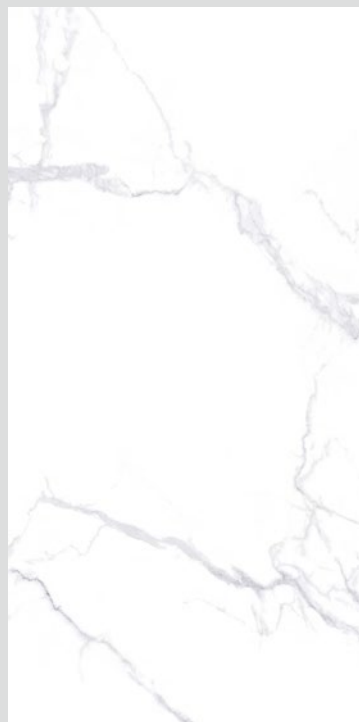

M01861218H (Matt 仿古面)
M01861218P (Full Polished Glazed 全抛釉)

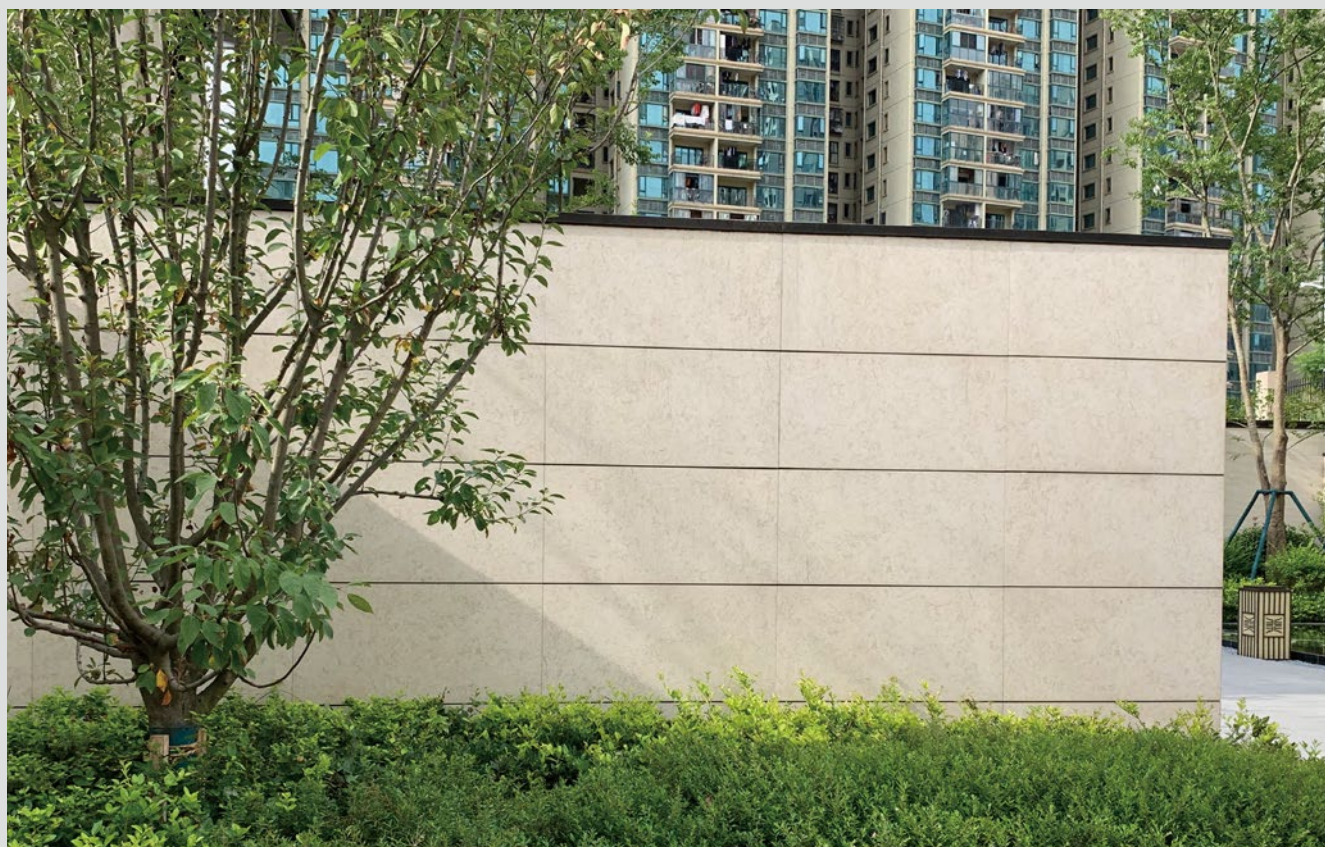

SIZE: 600x1200x18mm 景观厚砖

ONE STONE N FACE

N

Hermes Grey | 爱马仕灰

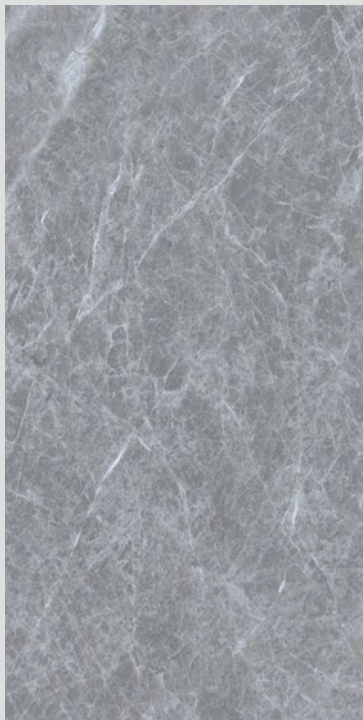

M02361218H (Matt 仿古面)
M02361218P (Full Polished Glazed 全抛釉面)

Blue Eyes | 蓝眼睛



M02561218R (Matt 仿古面)
M02561218P (Full Polished Glazed 全抛釉面)

Castle GrEy | 古堡灰



M03361218H (Matt 仿古面)
M03361218P (Full Polished Glazed 全抛釉面)

Surface: Matt 仿古面 / Full Polished Glazed 全抛釉 | Body: FullBody 斑点坯

Peral Blue | 珍珠蓝



M03761218H (Matt 仿古面)
M03761218P (Full Polished Glazed 全抛釉面)

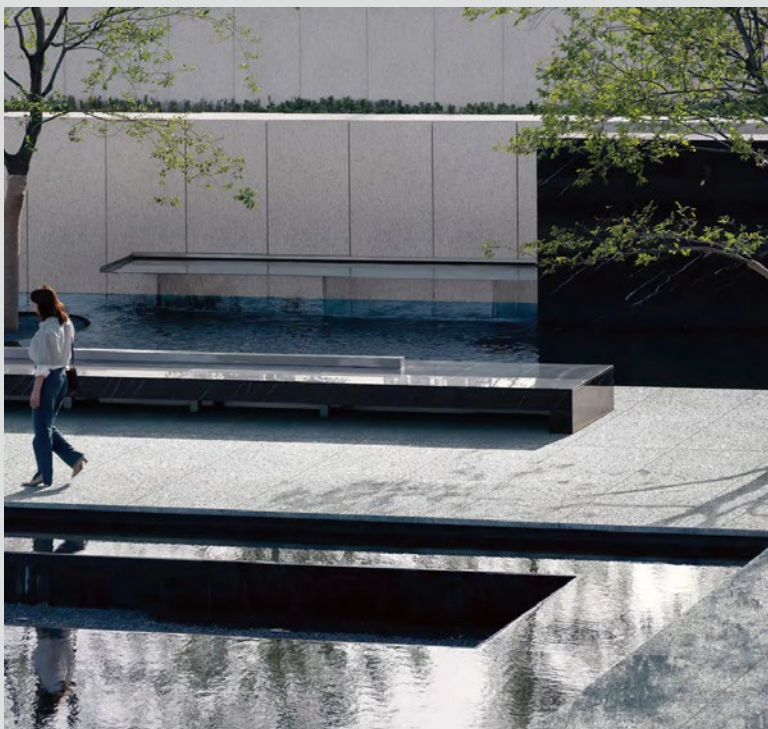

Surface: Matt 仿古面 / Full Polished Glazed 全抛釉 | Body: FullBody 斑点坯

SIZE: 600x1200x18mm 景观厚砖

ONE STONE N FACE

N

France Timber | 法国木纹 Surface: Matt 仿古面 / Full Polished Glazed 全抛釉 | Body: FullBody 斑点坯

白木纹



M20261218H (Matt 仿古面)

M20261218P (Full Polished Glazed 全抛釉面)

黄木纹



M20161218H (Matt 仿古面)

M20161218P (Full Polished Glazed 全抛釉面)

灰木纹



M20361218H (Matt 仿古面)

M20361218P (Full Polished Glazed 全抛釉面)



SIZE 600x1200X18mm 景观厚砖 (定制)

ONE STONE IN FACE

N

Portugal Cream | 葡萄牙米黄



M00261218P

Aquilaria Beige Stone | 沉香米黄碎纹



M01161218P

Travertine Beige | 黄洞石



M02261218P

Surface: Full Polished Glazed 全抛釉 | Body: FullBody 斑点坯

Bethel White | 美国白麻



M02161218P

EnglishBrown | 英国棕



M02661218P

Yuzuan Stone | 羽钻



M02761218P

Surface: Full Polished Glazed 全抛釉 | Body: FullBody 斑点坯

SIZE: 600x1200x18mm 景观厚砖

ONE STONE N FACE

N

Kamaisi Gold Stone | 卡麦斯金



M03061218P (定制)

Surface: Full Polished Glazed 全抛釉

Cyprus Grey | 路易斯灰



M03461218P (定制)

Body: FullBody 斑点坯

China Black | 中国黑

Body: Grey Body 灰坯

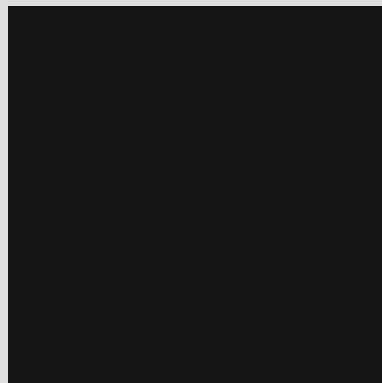

M0206018P
600x600mm

Black Galaxy | 黑金沙 II代

Body: Grey Body 灰坯



M0526018P 600x600mm
M05261218P 600x1200mm

Surface: Full Polished Glazed 全抛釉 | Body: GreyBody 灰坯

SIZE: 300x600x15/18/20mm 600x600x15/18/20mm
300x900x15/18/20mm 600x1200x15/18/20mm 麻石系列

Surface:Leechee +Granular R11 荔枝面 + 干粒 | Body: FullBody 斑点坯

Seasame White | 芝麻白

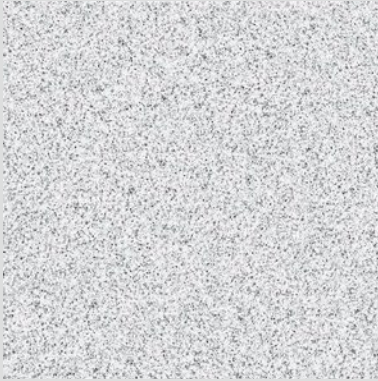

G1036018L

Seasame Grey | 芝麻灰

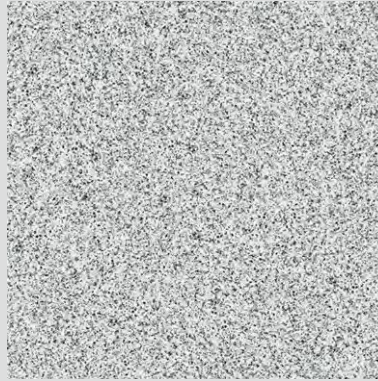

G1056018L

Seasame Black | 芝麻黑

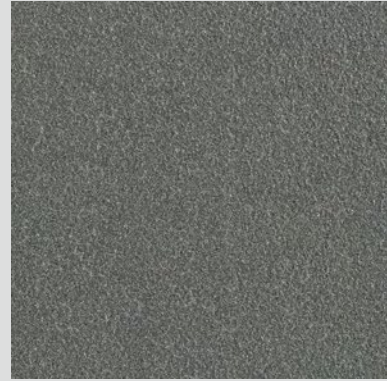

G1066018L

Rust Stone | 黄锈石



G1126018L

GialloCecilia | 黄金麻



G2226018L

Black Fuding | 福鼎黑

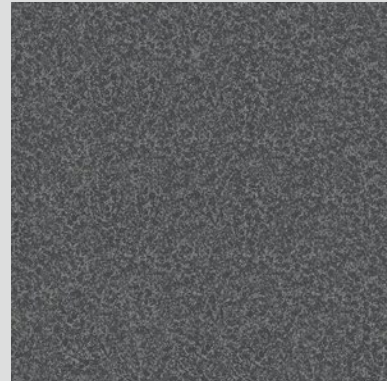

G3326018L



SIZE: 600x1200x20mm/600x600x20mm 景观厚砖

ONE STONE N FACE

N

LV Sandstone | 路易摩登砂岩



FLV61201HG 600x1200x20mm

FLV61202HG 600x1200x20mm

FLV61203HG 600x1200x20mm

FLV01HG 600x600x20mm

FLV02HG 600x600x20mm

FLV03HG 600x600x20mm

Surface: Flame +Granular R11 火烧面 + 干粒 | Body: FullBody 斑点坯



Plain Sycamore | 橡木 Surface: Anti-Slip 干粒防滑面 R11 | Body: FullBody 斑点坯



PTW01H



PTW02H



PTW05H

Bologa Terrazzo | 博洛那水磨石 Surface: Anti-Slip 干粒防滑面 R11 | Body: FullBody 斑点坯



BLA01H



BLA03H

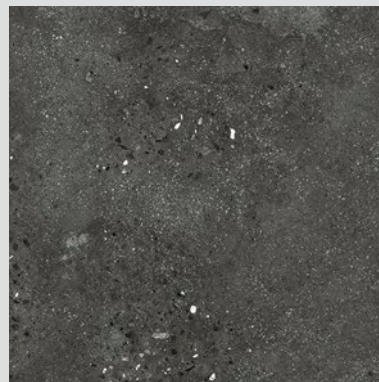

BLA04H

Slab Stone | 青石



M0406018F

Slab Stone | 青石 A

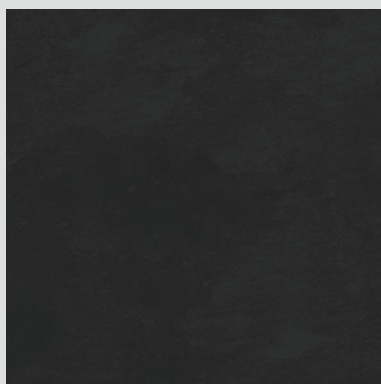

M0416018F

Black Marquina | 黑白根

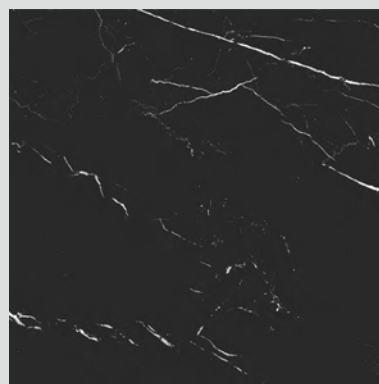

M0506018F

SIZE: 600x600x20mm 景观厚砖

ONE STONE N FACE

N

Dawn | 黎明石 Surface: Anti-Slip 干粒防滑面 R11 | Body: FullBody 斑点坯



DA02H



DA06H

Midnight | MD Surface: Anti-Slip 干粒防滑面 R11 | Body: FullBody 斑点坯



MD02H



MD03H

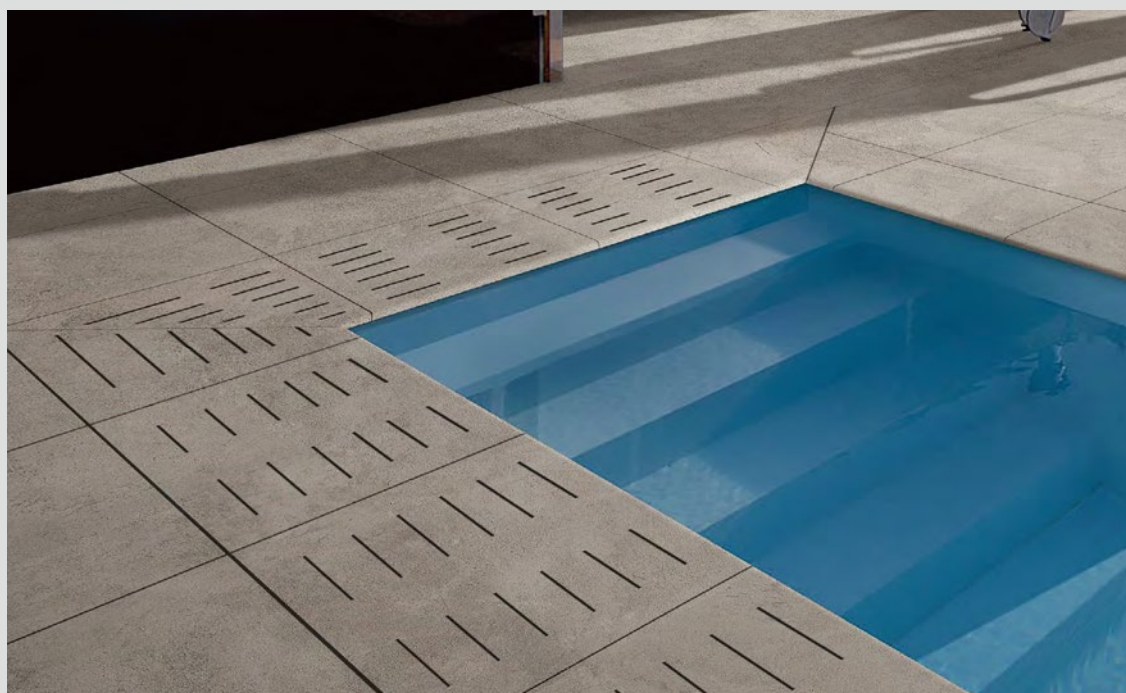

SIZE: 600x600X18mm 景观厚砖

ONE STONE N FACE

N

M0396018F | 土耳其板岩 Surface: Anti-Slip R10 止滑釉 | Body: FullBody 斑点坯





MORDEN GLAZED PORCELAIN TILE

现代仿古砖

路易摩登板岩系列 LV Slate Series

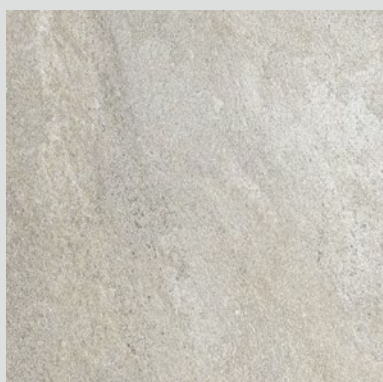

FLV01

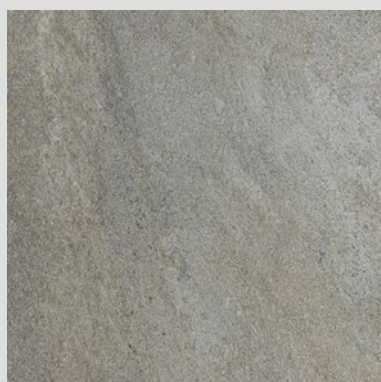

FLV02

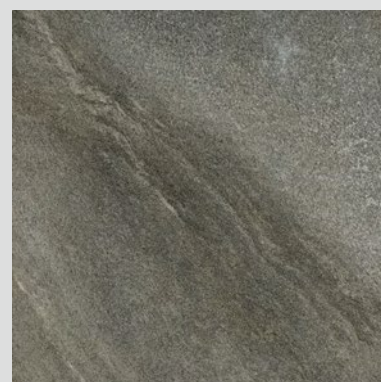

FLV03

Surface: Structured+Granular 模具干粒面 | Body: NormalBody 普坯



MORDEN GLAZED PORCELAIN TILE

现代仿古砖

凯撒水泥系列

Riverside Series



VRD01



VRD03



VRD04

Surface: Matt+Structrued 哑面模具面 | Body: NormalBody 普坯



MORDEN GLAZED PORCELAIN TILE

现代仿古砖

西澳云贝砂岩系列 Reefstone Series



RF1660A



RF1665A



RF1666A

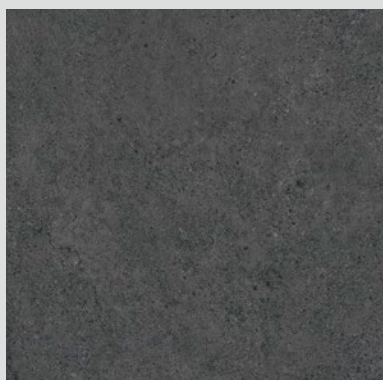

RF1669A

Surface: Anti-Slip R11 干粒防滑面 | Body: Full Body 斑点坯

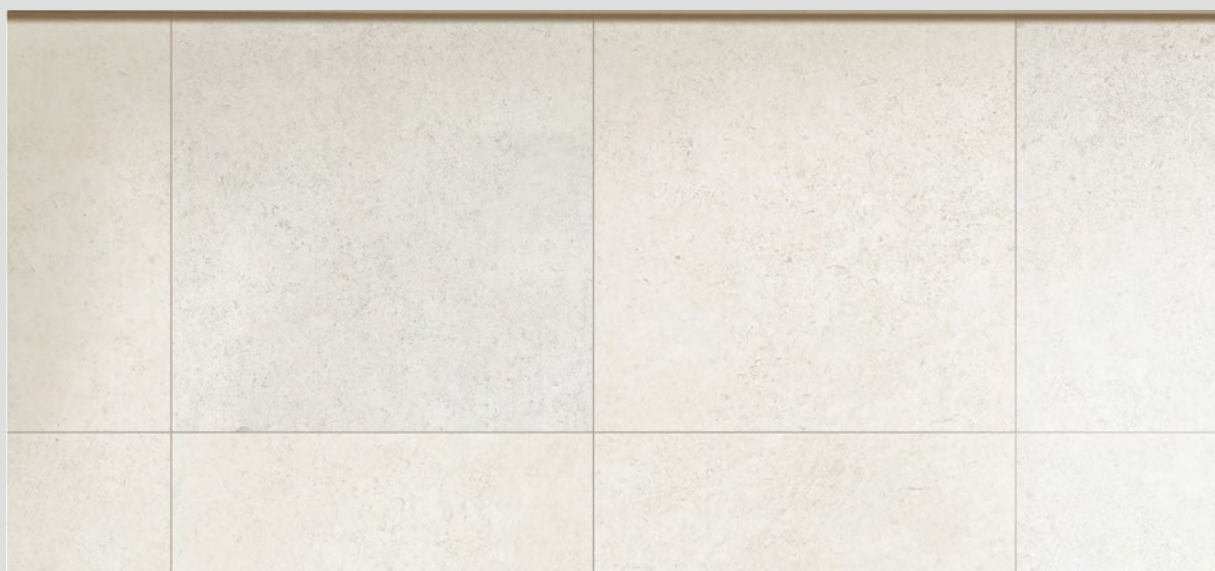

MORDEN GLAZED PORCELAIN TILE

现代仿古砖

木化石系列 Natural Wooden Stone



612WMH01B



612WMH02B



612WMH03B

Surface: Granular + lappato 细干粒 + 蜡抛 | Body: FullBody 斑点坯

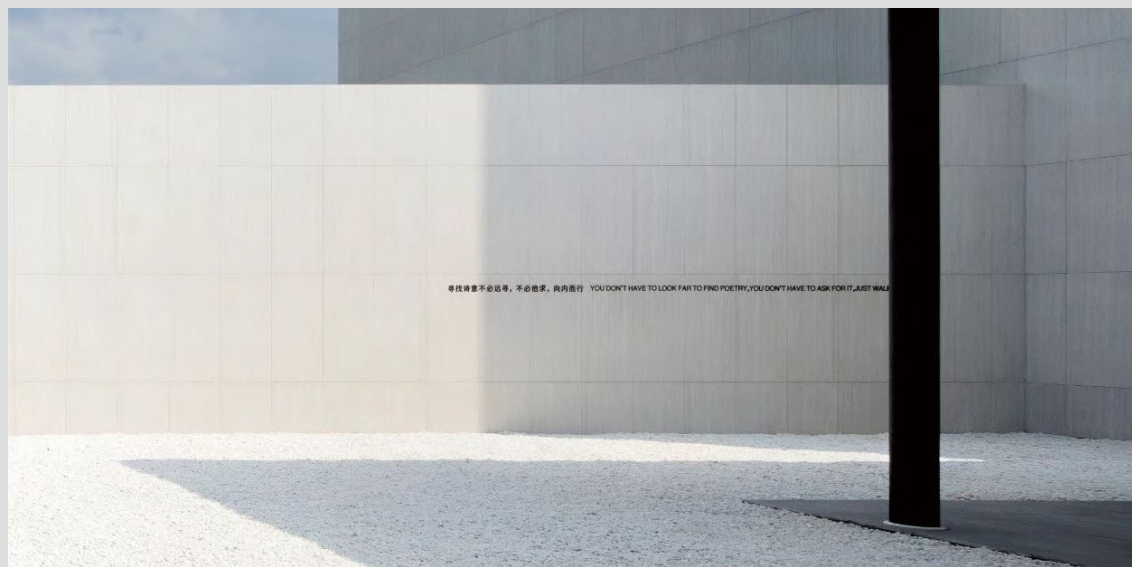

MORDEN GLAZED PORCELAIN TILE

现代仿古砖

都灵岩画系列 Turin Rock Art



MR612601



MR612602



MR612603



MR612609

Surface: Carving Glaze Matt 精雕仿古 | Body: Full Body 斑点坯

MORDEN GLAZED PORCELAIN TILE

现代仿古砖

素色臻石系列 Morden Pure Color Stone



FSP612501



FSP612503



FSP612505



FSP612509

Surface: Matt 哑面 | Body: Full Body 斑点坯

工程案例实景

集美东方

项目类型：住宅公寓、户外地面、外墙干挂

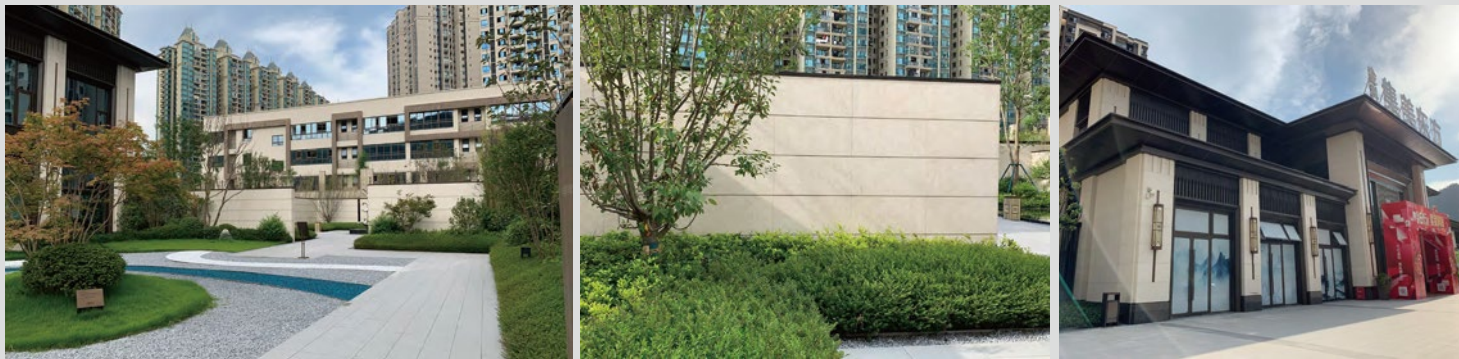

工程案例实景

金科集团（万云府）

项目类型：住宅公寓、户外地面



工程案例实景

博翠天悦

项目类型：住宅公寓、户外地面

工程案例实景

金科禹洲府

项目类型：
商业空间、户外地面、
外墙干挂

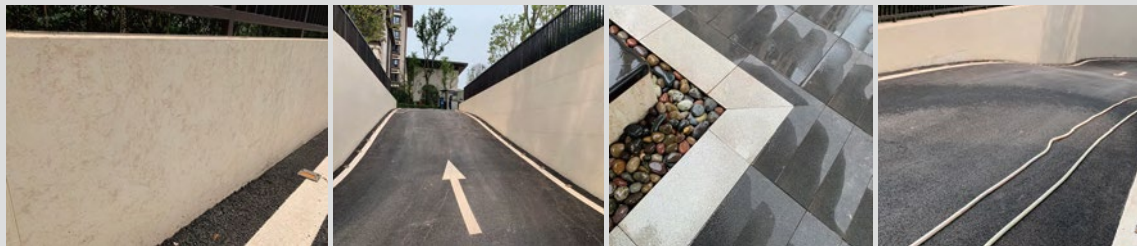

营销中心：常州市新北区通江路593号金田大厦828-830室

OFFICE & SHOWROOM: 593, Tongjiang Road | Jintian Plaza 828-830 | Changzhou 213022 | Jiangsu, China

电话：0519 8988 3171

网址：www.decorlux.cn

